

SPG

SPG SERIES SINGLE POINT LOAD CELLS, C3 CLASS

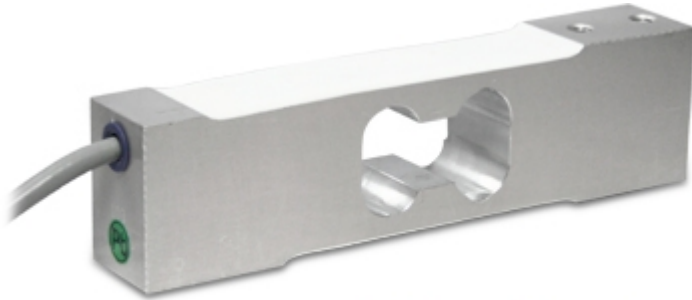

Load cells for off center loads, suitable for example to build CE-M approved scales with a single load cell; maximum platform dimensions of 600x600 mm.

---

**CAPACITIES (kg):** 10, 15, 20, 30, 50, 100, 200.

---

**OIML R60. C3** precision class.

---

**Aluminium** alloy. **IP67** protection.

---

The best solution  
for advanced industrial  
applications

## MAIN FEATURES

- C3 PRECISION CLASS
- OFF CENTER LOAD COMPENSATED
- ALUMINIUM ALLOY CONSTRUCTION
- IP67 PROTECTION
- MAX. CAPACITIES FROM 10 TO 200 kg
- FOR PLATFORMS WITH DIMENSIONS UP TO 600 X 600 mm
- SHIELDED CONNECTION CABLE
- OIML CERTIFICATE AVAILABLE UPON REQUEST
- TEST CERTIFICATE AVAILABLE UPON REQUEST

## TECHNICAL FEATURES

- Minimum load cell verification interval:  
 $V_{min} = E_{Max} / 10.000-15.000$
- Maximum number of verification intervals:  $n_{LC} = 3000$
- Sensitivity:  $2mV/V \pm 10\%$
- Temperature effect on zero:  
from  $\pm 0,0093\% \text{ F.S./10K}$  to  $\pm 0,0140\% \text{ F.S./10K}$
- Temperature effect on Full Span:  
 $0,011\% \text{ F.S./10K (-10}^\circ\text{C/+20}^\circ\text{C)}$   $0,017\% \text{ F.S./10K (+20}^\circ\text{C/+40}^\circ\text{C)}$
- Compensated Temperature Range:  $-10^\circ\text{C/+40}^\circ\text{C}$
- Operating Temperature Range:  $-10^\circ\text{C/+50}^\circ\text{C}$
- Maximum excitation voltage without damage: 15 Vdc
- Input Resistance: 300..500 Ohm
- Output Resistance: 300..500 Ohm
- Zero Balance:  $0 \pm 0,12 \text{ mV/V (at 100 V)}$
- Insulation Resistance:  $>2000 \text{ MOhm}$
- Mechanical limit load in service: 150% F.S.
- Destructive load: 300% F.S.
- Deflection at nominal load  $<0,5\text{mm}$
- 6-wire shielded cable, 3m long, 4,7mm diameter

## ATEX Version

- The CCATEX certificate makes the load cell suitable for use in hazardous areas with protection methods according to:  
ATEX II 1G Ex ia IIC T6 (Ta  $-20 \div +40^\circ\text{C}$ ) TX (Ta  $-20 \div +65^\circ\text{C}$ ) Ga  
ATEX II 1D Ex ta IIIC TX $^\circ\text{C}$  (Ta  $-20 \div +40^\circ\text{C}$ ) TX $^\circ\text{C}$  (Ta  $-20 \div +65^\circ\text{C}$ ) Da IP65.  
The certificate includes the manual and the ATEX CE conformity declaration (available in EN, DE, FR, and IT).
- **IMPORTANT:** the certificate refers to the single load cell. For systems with more load cells, it is necessary to order one certificate for each load cell.

## DETAIL 1

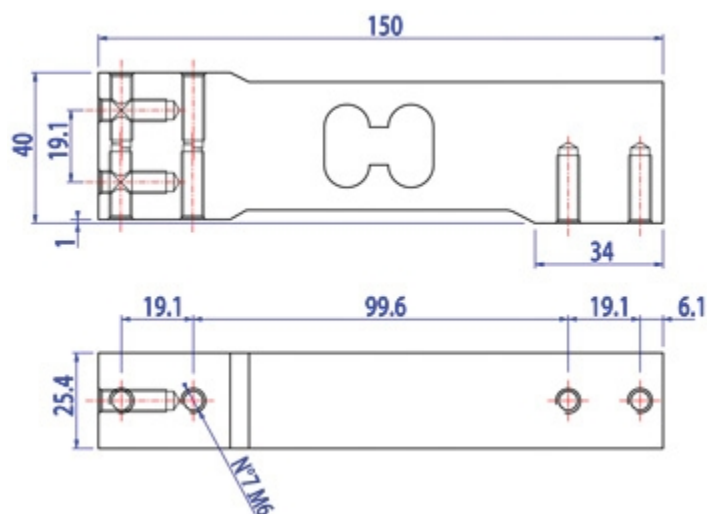







Dimensions (mm)

Wiring Code	
Colour	Function
YELLOW	SHIELD
WHITE	OUTPUT +
GREEN	SENSE +
BLUE	INPUT +
RED	OUTPUT -
GREY	SENSE -
BLACK	INPUT -

## VERSIONS

### Available versions

Codice	Piatto Max (mm)	Max (kg)
SPG10-1 	300x300	10
SPG15-1 	450x450	15
SPG20-1 	450x450	20
SPG30-1 	450x450	30
SPG50-1 	600x600	50
SPG100-1 	600x600	100
SPG200-1 	600x600	200

**COVENTRY SCALE COMPANY** 

COVENTRY SCALE COMPANY LTD

UNIT 8, SPITFIRE CLOSE - CV5 6UR - COVENTRY

Tel. 0044-2476-593500

Fax. 044-2476-601239

E-mail [info@coventryscale.co.uk](mailto:info@coventryscale.co.uk)

Web [www.coventryscale.co.uk](http://www.coventryscale.co.uk)